



BLUEBEAM REVU | **KEYBOARD SHORTCUTS**

Mouse Navigation

Middle Button (wheel)

Pan = Click + Drag

Re-Center View = Double-Click

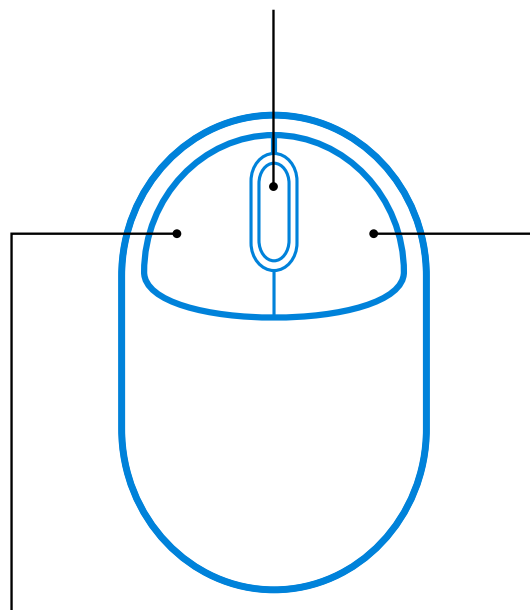

Left Button

Tool Operation = Click

Pan = Click + Spacebar

Multi-Select = Shift + Click + Drag

Right Button

Context Menu = Click

Multi-Select = Click + Drag

Mouse for 3D Navigation

Middle Button (wheel)

Zoom In/Out = Scroll

Pan Model = Click + Drag

Return to View = Double-Click

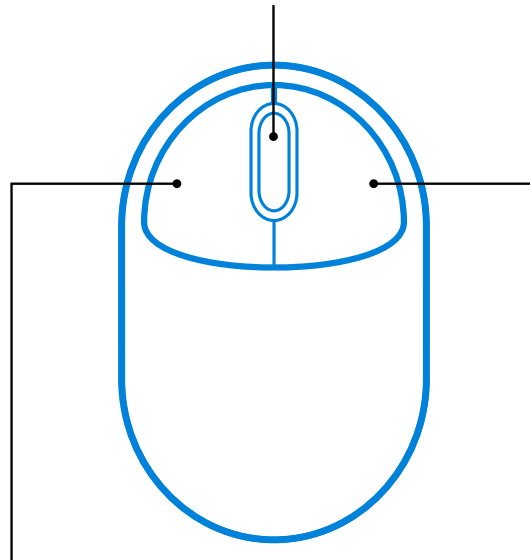





























Left Button

























Rotate Model = Click + Drag

Right Button

Rotate Camera = Click + Drag









Markup & Editing

Cloud	C	
Cloud+	K	
Ellipse	E	
Eraser	Shift + E	
Snapshot	G	
Highlight	H	
Hyperlink	Shift + H	
Image	I	
Line	L	
Arc	Shift + C	
Arrow	A	
Dimension	Shift + L	
Note	N	
Polyline	Shift + N	
Lasso	Shift + O	
Pen	P	
Polygon	Shift + P	
Callout	Q	
Rectangle	R	
Text Box	T	
Typewriter	W	
File Attachment	F	
Flag	Shift + F	
Format Painter	Ctrl + Shift + C	
Auto-Size Text Box	Alt + Z	
Dynamic Fill	J	
Measure Tool	M	
Length Measurement	Shift + Alt + L	
Polylength Tool	Shift + Alt + Q	







Perimeter Measurement	Shift + Alt + P	
Area Measurement	Shift + Alt + A	
Volume Measurement	Shift + Alt + V	
Count Measurement	Shift + Alt + C	123
Diameter Measurement	Shift + Alt + D	
Angle Measurement	Shift + Alt + G	
Radius Measurement	Shift + Alt + U	
Complete Markup	Enter	
Exit Current Command	Esc	
Edit Text in Comment	F2	
Flatten Markups	Ctrl + Shift + M	
Unflatten Markups	Ctrl + Shift + U	
Copy	Ctrl + C	
Paste	Ctrl + V	
Paste in Place	Ctrl + Shift + V	
Cut	Ctrl + X	
Undo	Ctrl + Z	
Redo	Ctrl + Y	
Align Bottom	Ctrl + Alt + B	
Align Left	Ctrl + Alt + L	
Align Right	Ctrl + Alt + R	
Align Top	Ctrl + Alt + T	
Flip Horizontal	Ctrl + Alt + H	
Flip Vertical	Ctrl + Alt + V	
Bring Forward	Ctrl +]	
Send Backward	Ctrl + [
Bring to Front	Ctrl + Shift +]	
Send to Back	Ctrl + Shift + [

Keyboard Shortcuts

Navigation

















Select	V	
Pan	Shift + V	
Previous Document	Ctrl + Shift + F6	
Next Document	Ctrl + F6	
Jump to First Page	Home	
Jump to Last Page	End	
Previous Page	Ctrl + Left	
Next Page	Ctrl + Right	
Previous View	Alt + Left	
Next View	Alt + Right	
Next Comment	Tab	
Previous Comment	Shift + Tab	
Next Tab	Ctrl + Tab	
Previous Tab	Ctrl + Shift + Tab	
Scroll Up	Up	
Scroll Down	Down	
Scroll Left	Left	
Scroll Right	Right	

Page Manipulation

Insert Blank Page	Ctrl + Shift + N	
Insert Pages	Ctrl + Shift + I	
Extract Pages	Ctrl + Shift + X	
Replace Pages	Ctrl + Shift + Y	
Delete Pages	Ctrl + Shift + D	
Rotate Pages	Ctrl + Shift + R	
Copy Page to Snapshot	Ctrl + Alt + C	
Deskew	Ctrl + Alt + D	
Rotate Clockwise	Shift + Alt + (=)	

Rotate Counterclockwise	Shift + Alt + (-)	
Crop Pages	Shift + Alt + O	

Show Tabs

Bookmarks Tab	Alt + B	
Markups List Tab	Alt + L	
Measurements Tab	Alt + U	
Properties Tab	Alt + P	
Search Tab	Alt + 1	
Thumbnails Tab	Alt + T	
Tool Chest™ Tab	Alt + X	
File Access™ Tab	Alt + A	
Bluebeam Studio™	Alt + C	
bFX™ Tab	Alt + K	
Layers Tab	Alt + Y	
Spaces Tab	Alt + S	
Links Tab	Alt + N	
Forms Tab *	Alt + Q	
JavaScript Console	Alt + J	
3D Model Tree	Alt + 3	
Sets Tab	Alt + 2	
Signatures Tab	Alt + 4	

Miscellaneous

Open Help Window	F1	
Toggle Navigation Bar	F4	
Toggle Status Bar	F8	
Toggle Menu Bar	F9	
Close Context Menu	F10	

